



Reading Scales to Measure in Litres and Millilitres

I can read scales to measure in litres and millilitres.



Write how much liquid is in each cylinder.

Cylinder 1:

Hint: There are 10 increments between 0 and 1l (1000ml).

Each increment is worth $1000\text{ml} \div 10 = 100\text{ml}$.

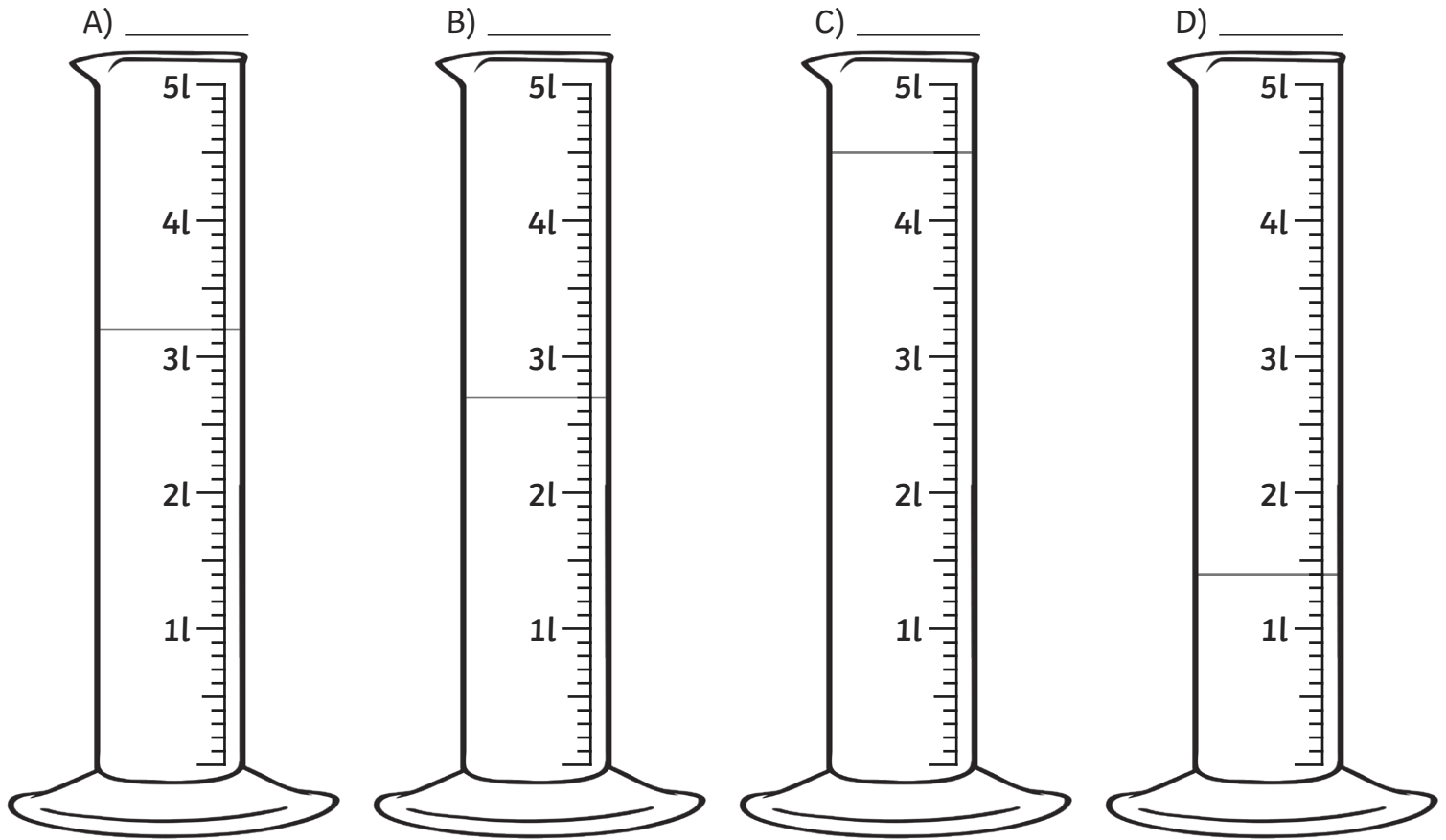



Cylinder 2:

Hint: There are 2 increments between 0 and 1l (1000ml).

Each increment is worth $1000\text{ml} \div 2 = 500\text{ml}$.

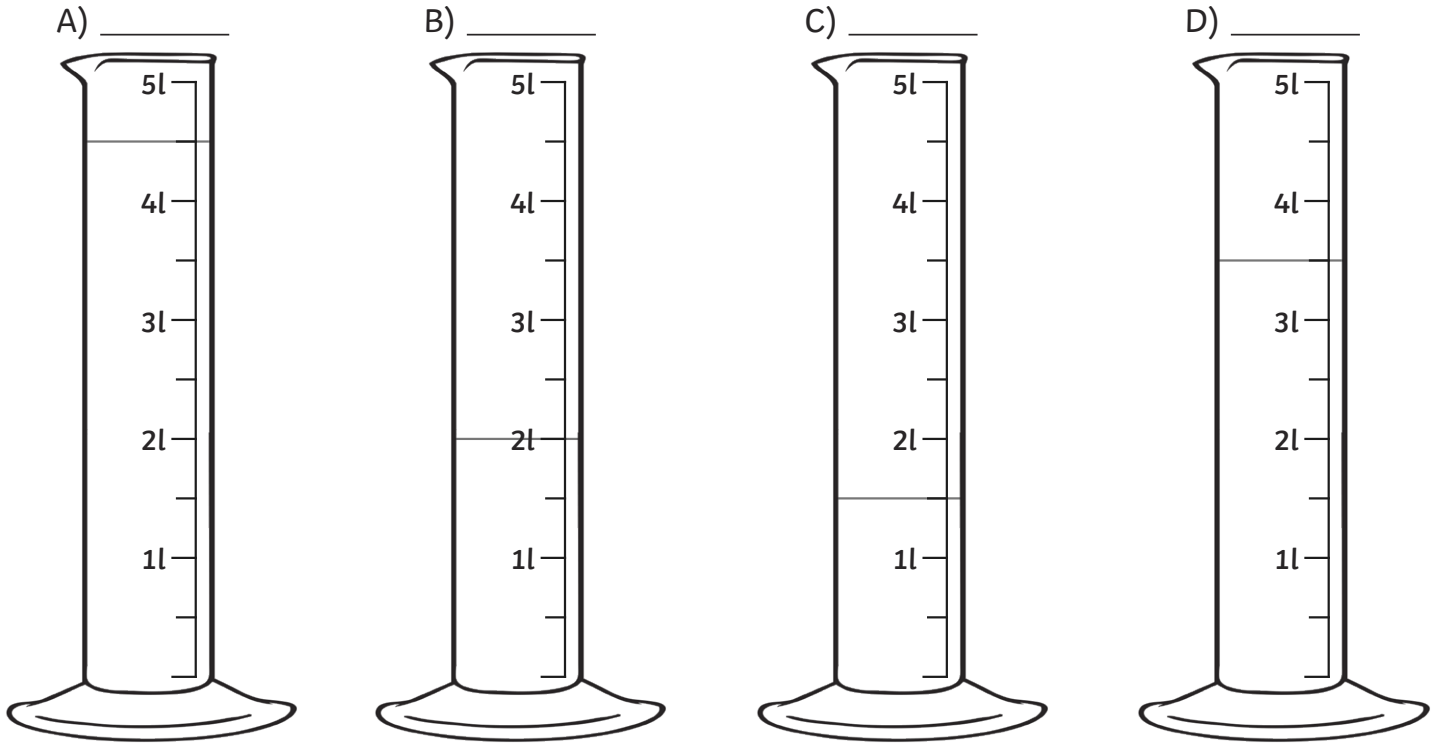

Cylinder 3:

Hint: There are 5 increments between 0 and 1l (1000ml).

Each increment is worth $1000\text{ml} \div 5 = 200\text{ml}$.

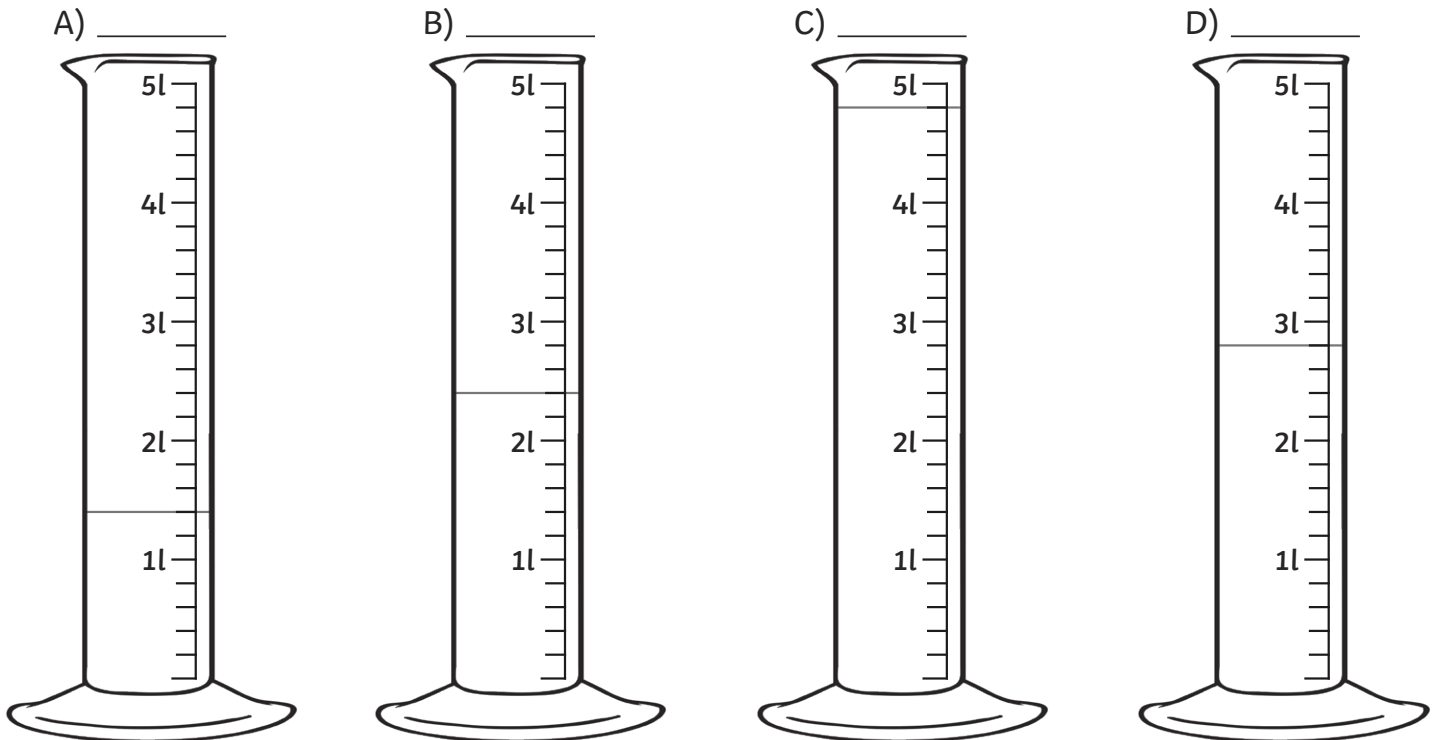

Reading Scales to Measure in Litres and Millilitres **Answers**

I can read scales to measure in litres and millilitres.



Question	Answer
1.	Write how much liquid is in each cylinder.
A)	<i>3l 200ml</i>
B)	<i>2l 700ml</i>
C)	<i>4l 500ml</i>
D)	<i>1l 400ml</i>
2.	Write how much liquid is in each cylinder.
A)	<i>4l 500ml</i>
B)	<i>2l</i>
C)	<i>1l 500ml</i>
D)	<i>3l 500ml</i>
3.	Write how much liquid is in each cylinder.
A)	<i>1l 400ml</i>
B)	<i>2l 200ml</i>
C)	<i>4l 800ml</i>
D)	<i>2l 800ml</i>



Reading Scales to Measure in Litres and Millilitres

I can read scales to measure in litres and millilitres.



Write how much liquid is in each cylinder.

Cylinder 1:

Hint: There are 10 increments between 0 and 1l (1000ml).

Each increment is worth $1000\text{ml} \div 10 = \underline{\hspace{2cm}}$ ml.

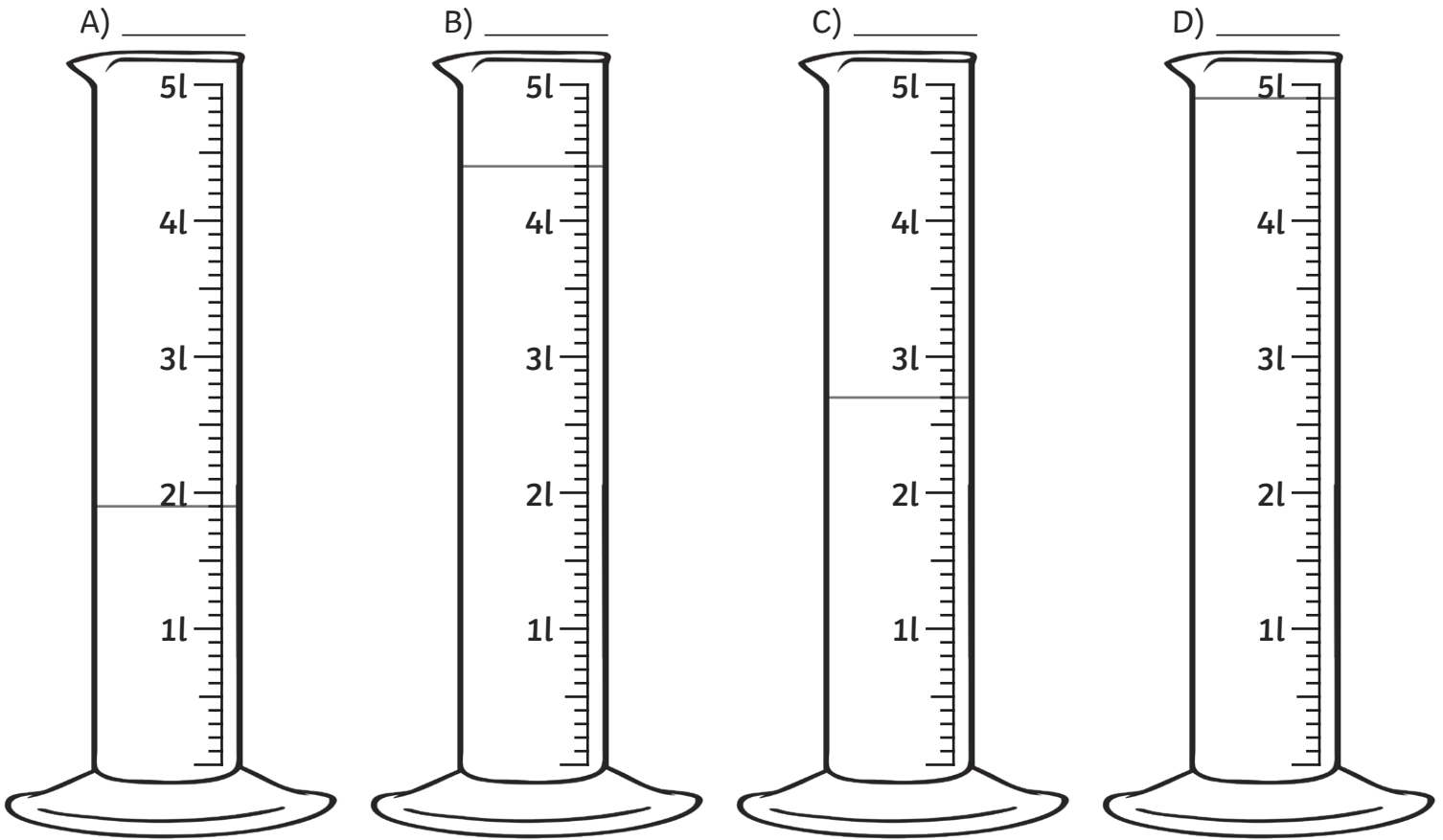



Cylinder 2:

Hint: There are 5 increments between 0 and 1l (1000ml).

Each increment is worth $1000\text{ml} \div 5 = \underline{\hspace{2cm}}$ ml.

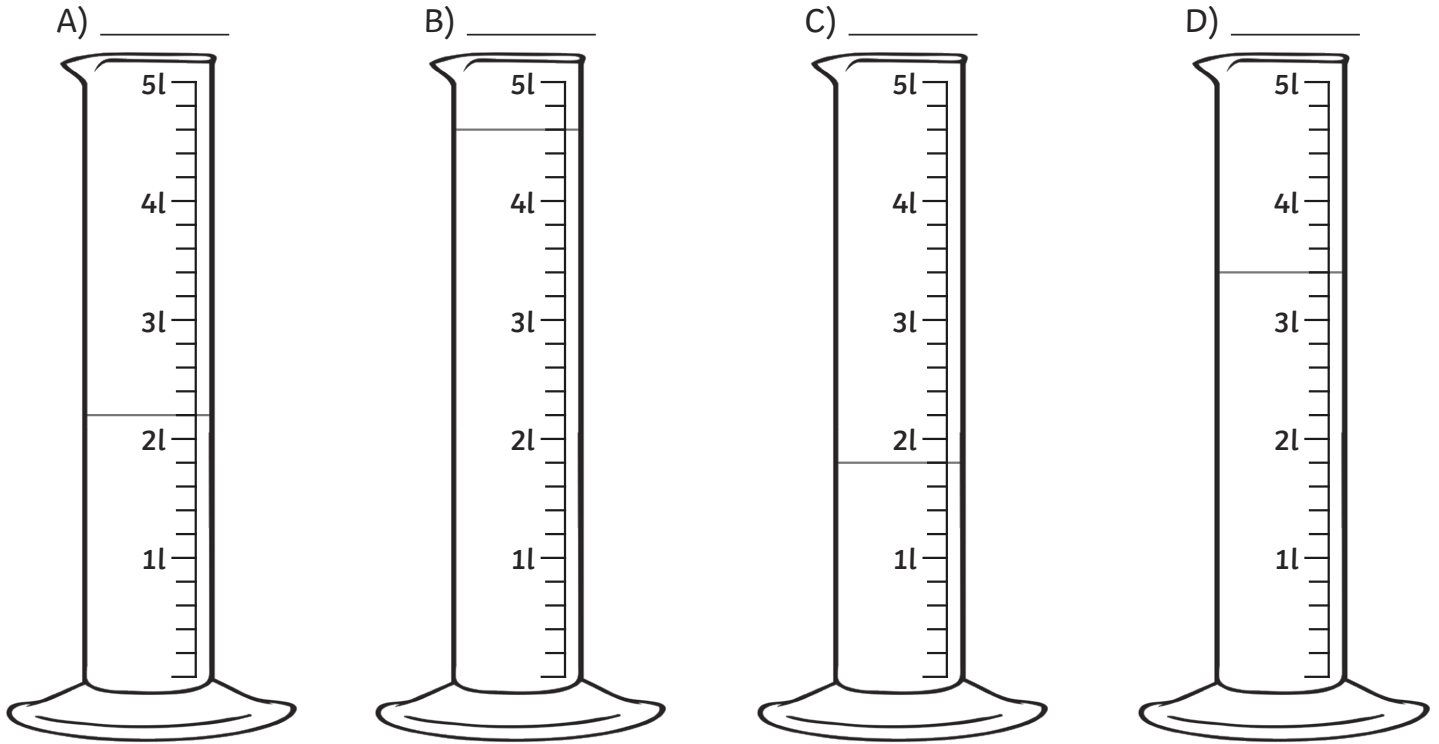

Cylinder 3:

Hint: There are 4 increments between 0 and 1l (1000ml).

Each increment is worth $1000\text{ml} \div 4 = \underline{\hspace{2cm}}$ ml.

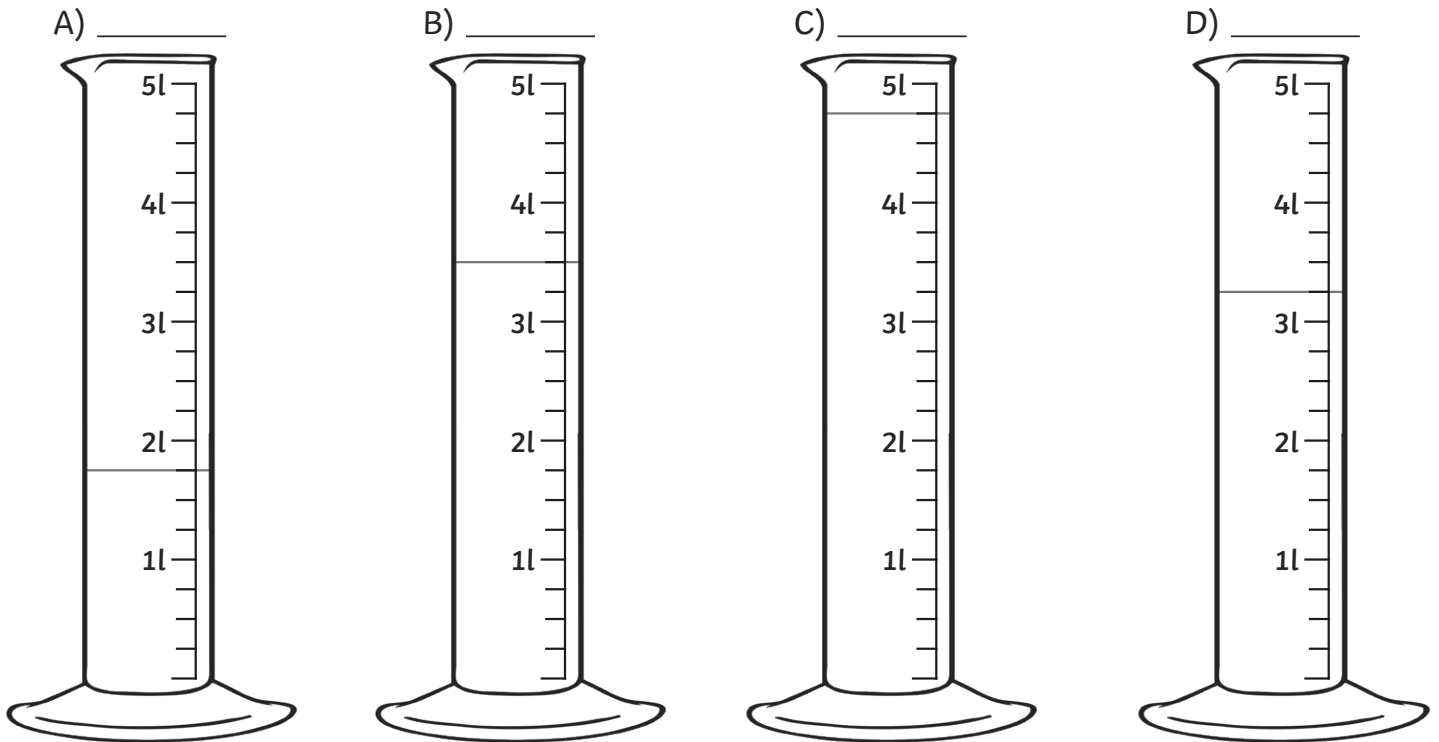



Reading Scales to Measure in Litres and Millilitres **Answers**

I can read scales to measure in litres and millilitres.



Question	Answer
1.	Each increment is worth $1000\text{ml} \div 10 = \underline{100}$ ml.
A)	<i>1l 800ml</i>
B)	<i>4l 400ml</i>
C)	<i>2l 700ml</i>
D)	<i>4l 900ml</i>
2.	Each increment is worth $1000\text{ml} \div 5 = \underline{200}$ ml.
A)	<i>2l 200ml</i>
B)	<i>4l 600ml</i>
C)	<i>1l 800ml</i>
D)	<i>3l 400ml</i>
3.	Each increment is worth $1000\text{ml} \div 4 = \underline{250}$ ml.
A)	<i>1l 750ml</i>
B)	<i>3l 500ml</i>
C)	<i>4l 750ml</i>
D)	<i>3l 250ml</i>



Reading Scales to Measure in Litres and Millilitres

I can read scales to measure in litres and millilitres.



Write how much liquid is in each cylinder.

Cylinder 1:

Explain how you know what each increment is worth.

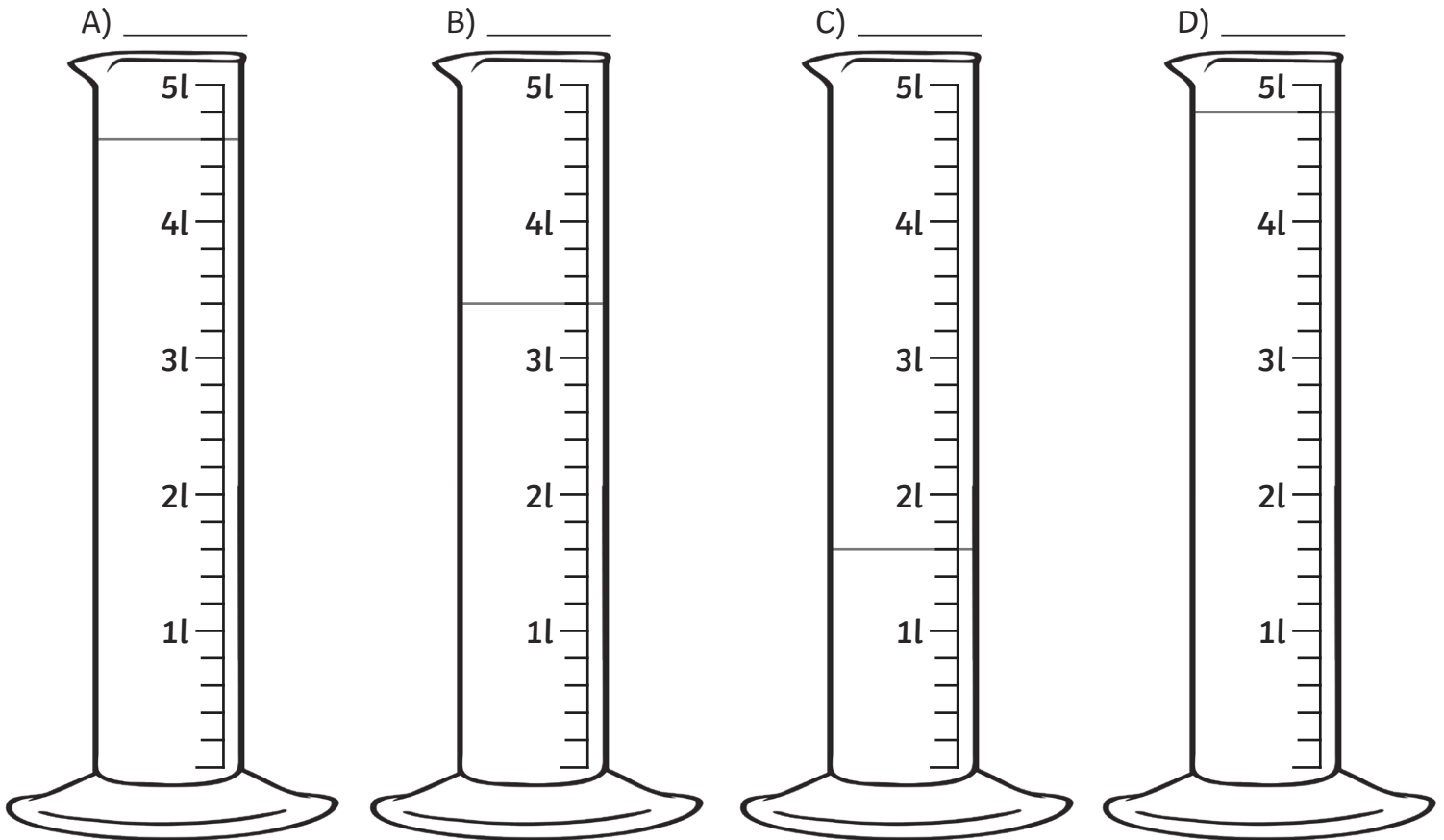



Cylinder 2:

Explain how you know what each increment is worth.

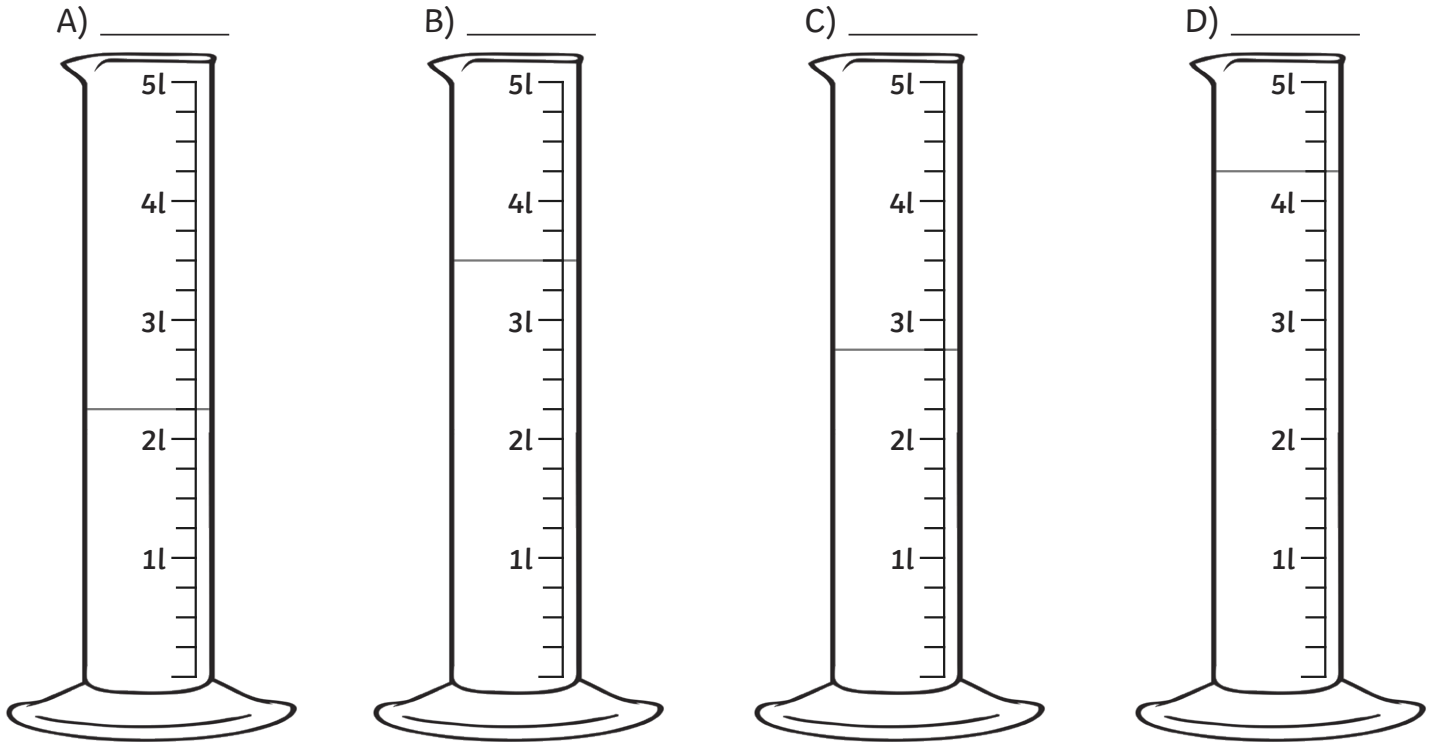

2) Fill each cylinder to the amount shown:

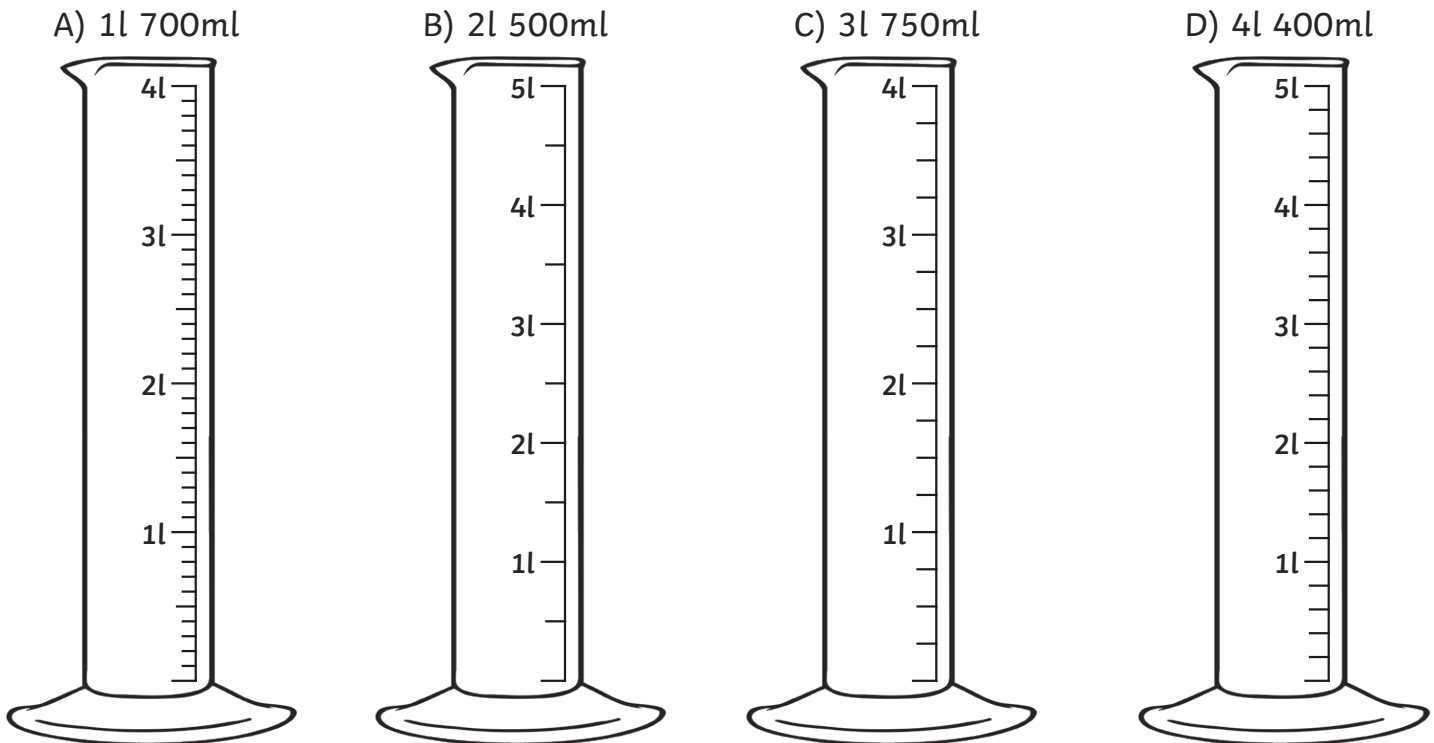

Reading Scales to Measure in Litres and Millilitres **Answers**

I can read scales to measure in litres and millilitres.

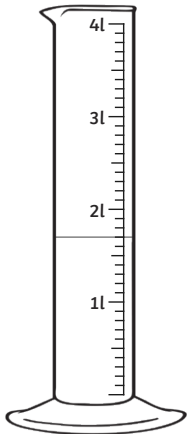
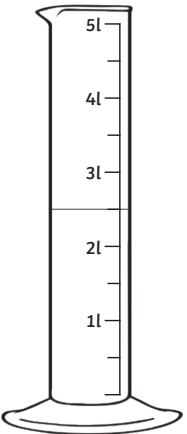
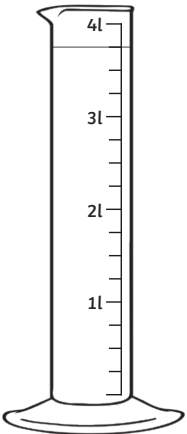

Question	Answer		
1.	A sentence explains how the increments are calculated. <i>1000 is divided by 5 to get 200ml.</i>		
A)	<i>4l 600ml</i>		
B)	<i>3l 400ml</i>		
C)	<i>1l 600ml</i>		
D)	<i>4l 800ml</i>		
2.	A sentence explains how the increments are calculated. <i>1000 is divided by 4 to get 250ml.</i>		
A)	<i>2l 250ml</i>		
B)	<i>3l 500ml</i>		
C)	<i>2l 750ml</i>		
D)	<i>4l 250ml</i>		
3.	Fill each cylinder to the amount shown:		
<p>A) 1l 700ml</p> 	<p>B) 2l 500ml</p> 	<p>C) 3l 750ml</p> 	<p>D) 4l 400ml</p> 